



alveni.com







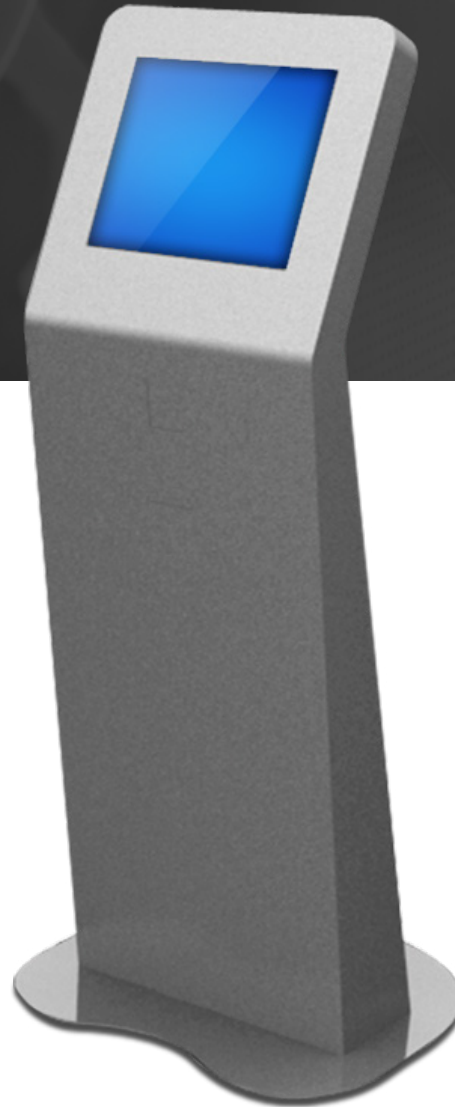

C SERIES



KIOSK C SERIES



This kiosk is ideal for:

-  Access information.
-  Internet access.
-  Human resources.
-  Virtual Remote Assistance.
-  Electronic surveys.
-  Customer service.
-  Tickets, receipts or coupon printing.

Features

The standard basic kiosk has the following features:

- All metal 16 gauge powder-coated steel.
- 1/4" thick metal Base plate.
- 80 mm cooling fan.
- Security CamLock and key.
- 22" PCAP touchscreen monitor.
- All in one, industrial grade PC.
- Contemporary design.
- All-metal enclosure.
- ADA compliant.
- Height adjustable base.
- Preparation in base to anchor to ground.

Specifications

- **Material**
Powder-coated steel.
- **Finishing**
Powder coated paint.
- **Monitor**
22" nti-vandal PCAPtouchscreen all in one .
- **CPU**
Industrial grade 8GB RAM, 120 SSD, Win 10, Intel i3.
- **Energy requirements**
110 V.
- **Safety**
Front door access with security camlock.
- **Weight**
Enclosure: 60 lbs. / With components: 140-160 lbs.
- **Temperature**
In operation: 42 - 113 °F (6-45 °C), for storage: 30 - 131 °F (0 - 55 °C).

Options

- **Colors**
Silver gray or premium color options.
- **Printer**
Laser letter size printer. Options for thermal printers available.
- **Peripherals**
Barcode reader, fingerprint reader, speakers, magnetic stripe reader, webcam, hybrid reader and many others (call for other options).
- **Sensors**
Temperature, humidity, proximity.
- **CPU**
Intel Core i3 processor, solid state drive options from 64GB to 128GB and 2 to 8 RAM available.
- **Networking**
Standard 10/100/1000 Ethernet, USB 802.11 b/g/n WIFI option.
- **OS**
Windows 10.
- **Keyboard**
Anti-vandal stainless steel 66 keys keyboard with trackball.
- **Monitor**
22" PCAP touchscreen monitor.
- **Enclosure options**
Stainless steel, aluminum or powder-coated steel.

- **Brochure racks**
Optional racks mounted on the sides of the kiosk for applications, brochures or collateral.
- **Graphics**
Custom graphics available upon request.
- **Monitoring and application lock down**
Software platform for remote monitoring, session control, security and content update.
- **Warranty**
1 year standard, can be extended to 3 years.

Technical drawing

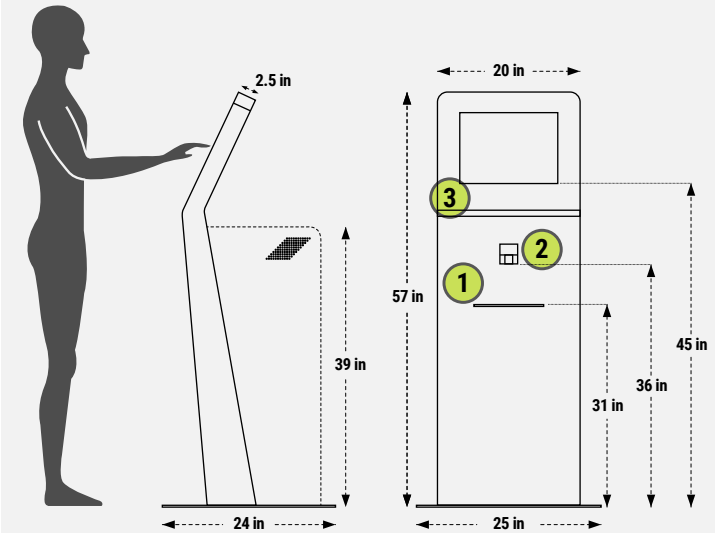

- ① Laser/thermal printer
- ② Barcode reader
- ③ Anti-vandal keyboard/trackball

*Design and measures may change according to the product updates.